



**THE FORTO-HT.  
FROM RÖHM.**



**IT DOESN'T MATTER  
WHAT YOUR MACHINE  
TOOL IS FACING.**



# THE FORTO-HT. FROM RÖHM.

The FORTO-HT is a hydraulic clamping cylinder with a through-hole for actuating power chucks and collet chucks. It is mainly used on CNC turning machines and machining centres for automatic clamping in hollow clamping. This makes it particularly well suited for machining long workpieces, up to bar material. In the FORTO-HT name, the H stands for hydraulics and the T for through-hole. It scores with the highest actuating forces and high speeds with very good smooth running at the same time.

Various (optional) rotary unions make it possible to feed media through to the clamping devices. Different (optional) travel measuring systems make it possible for the machine controller to monitor the piston stroke or alternatively piston position.

In the event of an unexpected pressure drop during machining, a safety device ensures that the actuating force is maintained until the spindle comes to an emergency stop.

The Forto-HT expands the hollow clamping cylinders product portfolio.



## FOR WHAT DEVICES

Automatic clamping, horizontal turning machines

## FOR WHAT WORK

Turning of rods, tubes, flanges, washers

## WHY

- large through-hole
- low weight
- short construction
- integrated coolant collector
- switching disc for travel measuring system outside the dirty area
- high speeds (up to 8,000 rpm in the 37/70 version)
- large selection of matching power chucks from RÖHM

## HOW MUCH

- excellent cost-effectiveness

# ACTUATES THAT, THAT, THAT, ... OR THAT

For clamping of clamping devices with a through-hole.

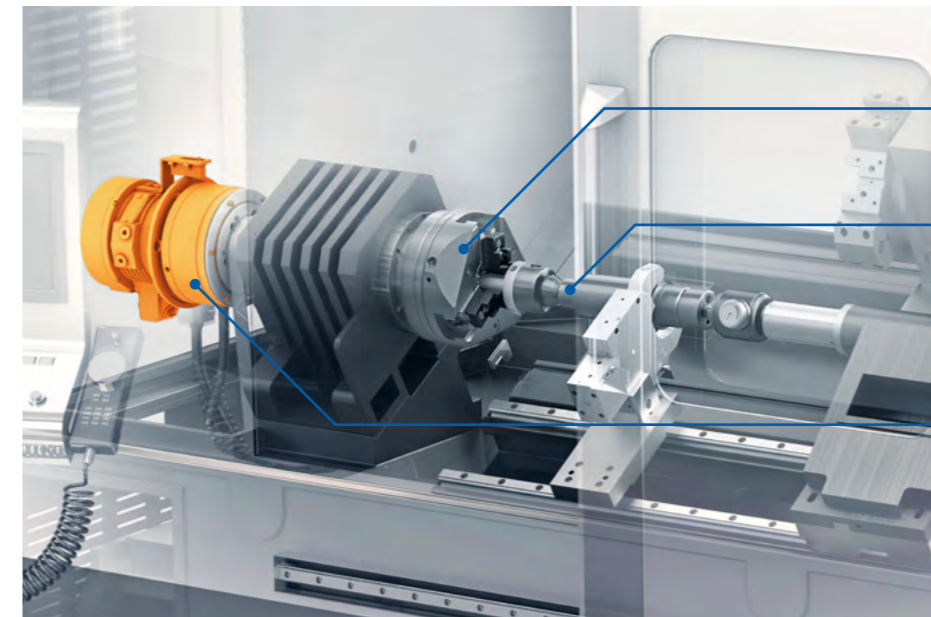

Force-actuated clamping device

Workpiece

Cylinder FORTO-HT

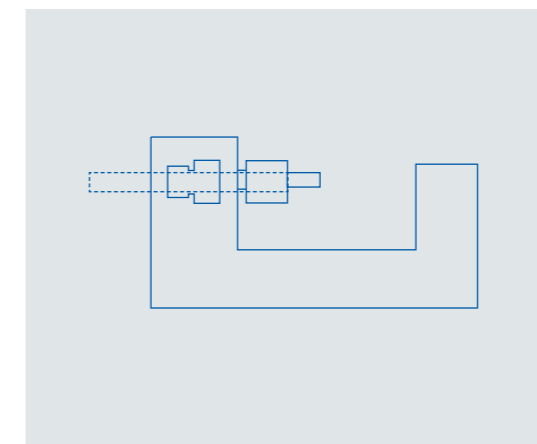

*The extra-large through-hole enables the machining of bar material with a large diameter in hollow clamping*

# THE HOLLOW CLAMPING CYLINDER OF THE FORTO-HT SERIES IS USED FOR FORCE-ACTUATED CLAMPING OF



Power chucks, like the DURO-A for example. From RÖHM.



Power chucks with a large through-hole, like the DURO-A-Plus or example. From RÖHM.



Power chucks with quick jaw change, like the DURO-A RC for example. From RÖHM.



Collets, like the Captis for example. From RÖHM.

## SO THAT YOU DON'T HAVE TO DEAL WITH COOLANT

Integrated coolant collector prevents coolant getting in the machine

For longer workpieces in particular, which protrude deep into the cylinder, the principle of hollow clamping cylinders calls for coolant on the workpiece that then drips off at the end of the cylinder. So that no coolant gets into the machine compartment, the FORTO-HT has an integrated coolant collector. The coolant collects here and is then fed back into the circuit. The coolant collector has a G1" connector at its lowest point.



Integrated coolant collector so that no coolant can penetrate into the machine compartment.

## IF YOU DON'T WANT LONGER PARTS TO GO TOO FAR

Connection for longitudinal stop ex works

As a hollow clamping cylinder, the FORTO-HT is suitable for mounting longer workpieces that protrude not only far into the chuck but also right into the cylinder. The integration of a longitudinal stop is expedient for manual loading. There is a connection possibility for this on the back side of the FORTO-HT. We would be happy to assist you with an individual longitudinal stop that is adapted to your requirements.



The FORTO-HT provides multiple threaded holes on the back side on the rotating flange that can be used for connecting a longitudinal stop, a material guide tube or a multi-port swivel.

## IF YOU REQUIRE A MULTI-PORT SWIVEL

Connection for multi-port swivel provided ex works

To be able to feed additional media (like hydraulic oil, compressed air, coolant etc.) to the clamping devices via the cylinder, there are suitable multi-port swivels. This is certainly a domain of full clamping cylinders, but if you require this at some time for a FORTO-HT hollow clamping cylinder, then we are ready. The FORTO-HT has a connection possibility on the back side for a multi-port swivel. We would be happy to assist you with a suitable adaptation.

Optional: F90  
travel measuring  
system

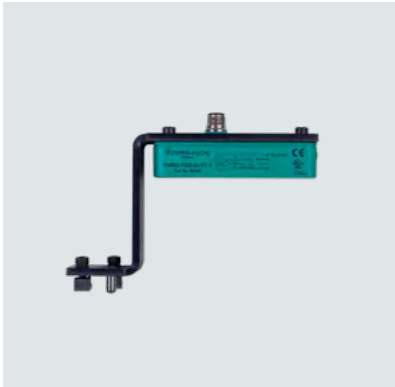

## IF YOU NEED TRAVEL MEASURING: F90

Optional: F90 travel measuring  
system for stroke monitoring

How do you monitor the stroke in the cylinder? This is almost always handled by a travel measuring system that inductively (i.e. contactless) detects the position and/or the two end positions of the piston. The FORTO-HT is prepared for this. The switching disc for stroke monitoring is integrated in the cylinder at the factory. There is also the optional F90 travel measuring system from RÖHM that is compatible with this. The F90 has very high resolution and only minimal temperature drift. It is prepared for the FORTO-HT and ready to screw on.

Optional: Integration of position  
and travel measuring systems  
via a mounting bracket

If you ask us, then you should reach for the F90 linear travel measuring system. But perhaps you already asked someone else who recommended another system to you. And, you now have many of that system in use. Too bad, but not a problem. You can also use the FORTO-HT with other inductive limit switches such as those from Balluff or the Bero from Pepperl+Fuchs. The connections for this as well as the switching disc (width: 8 mm) are available ex works.

The one thing that all variants have in common, is that they work outside the dirty area and supply reliable data.

The inductive F90  
travel measuring system  
is mounted on the  
outside of the FORTO-HT.



## IF YOU HAVE TO INTEGRATE ANOTHER STROKE MONITOR

## IF YOU REQUIRE RELIABLE AND SECURE STROKE MONITORING

Switching disc outside  
the dirty area

A safety system is only as good as the accuracy of its mount. Therefore, our designers invested a great deal of care in the placement of the switching disc. We know that even small impurities on the switching disc can lead to a malfunction of the sensor in the travel measuring system. Therefore, we designed the actuating disk to be outside of the dirt and chips area.



*You can expect a very clever design: The switching disc is connected to the piston on the inside and can be picked up from the outside. That way the sensor system is placed completely outside the dirty area.*

## INSTALLATION

### IF YOU REQUIRE A FLEXIBLE LEAKAGE OIL CONNECTION

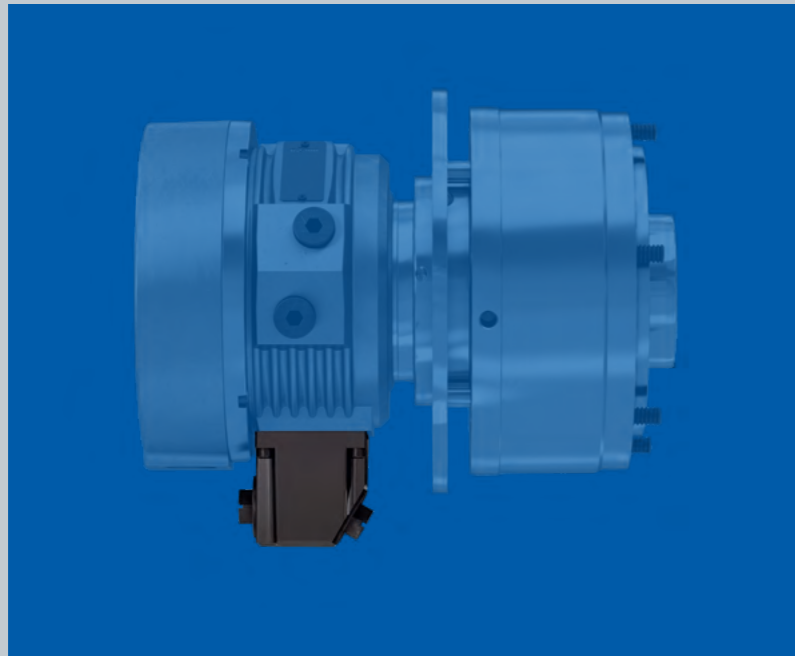

#### Swivelling leakage oil nozzle for tight installation spaces

Because of their working principle, rotating assemblies—like the piston and housing—can never be designed to be completely oil-tight (especially at working pressures of up to 45 bar). We designed the FORTO-HT so that the accruing quantities of leakage oil are collected at the lowest point of the distributor housing and are then fed back into the hydraulic oil system via the leakage oil nozzle. To make it easy to integrate the FORTO-HT, especially in tight machine tool spaces, the leakage oil nozzle is designed so that it can be swivelled by 4x 90°. It has a G3/4" connector.

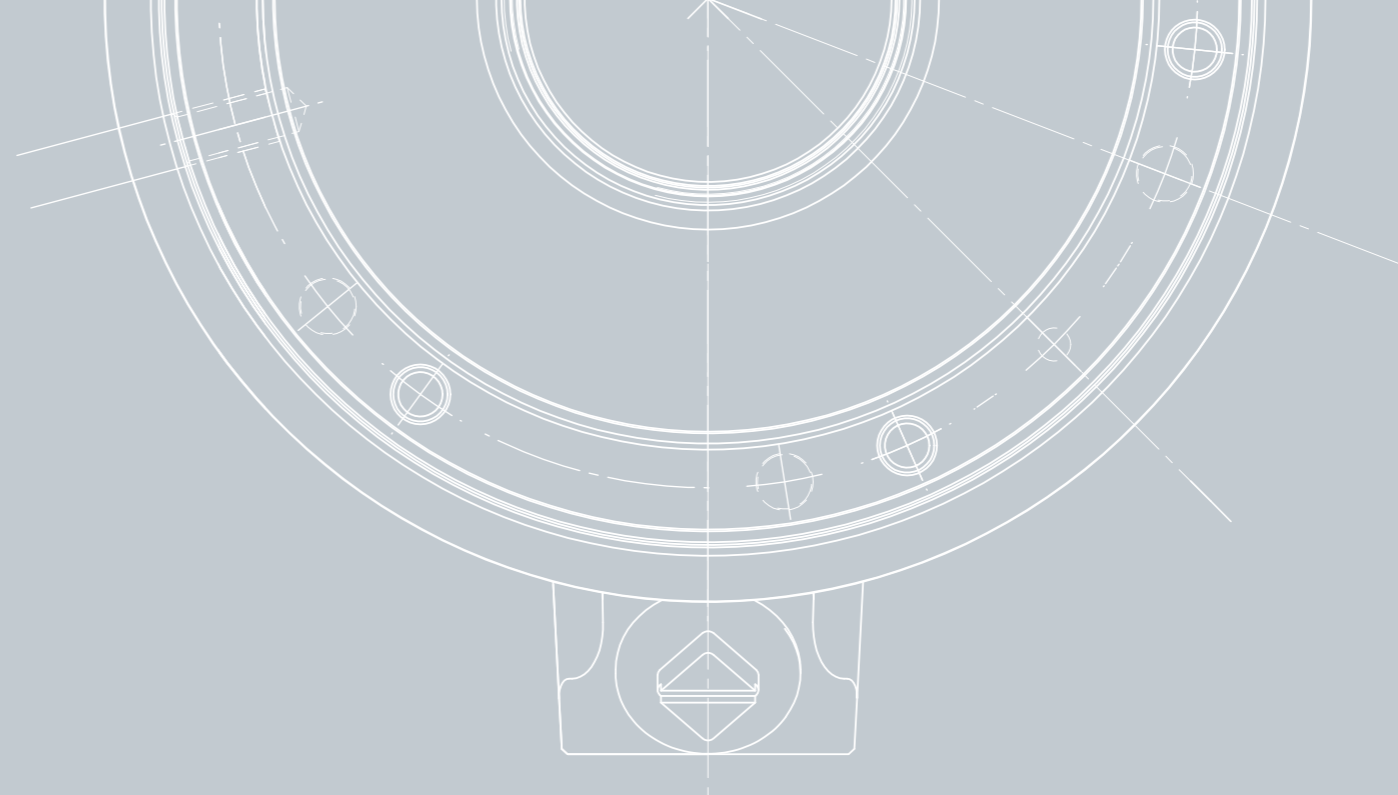

### HOW DOES THE FORTO-HT GET ONTO YOUR MACHINE TOOL?

#### Six threaded connections on the back side

The FORTO-HT is screwed to the machine spindle from the back with six through bolts (included with delivery).

G3/8" (pressure lines) and G3/4" (return line) connectors are provided for connecting to the hydraulic supply. The connectors for the pressure lines are found on both sides of the cylinder.

A drawtube is used for the connection to the clamping device. This drawtube is always individual and is configured from the combination of cylinder – clamping device – machine tool. We would be happy to assist you with the design and manufacture of the right drawtube for your configuration.

TECHNOLOGY

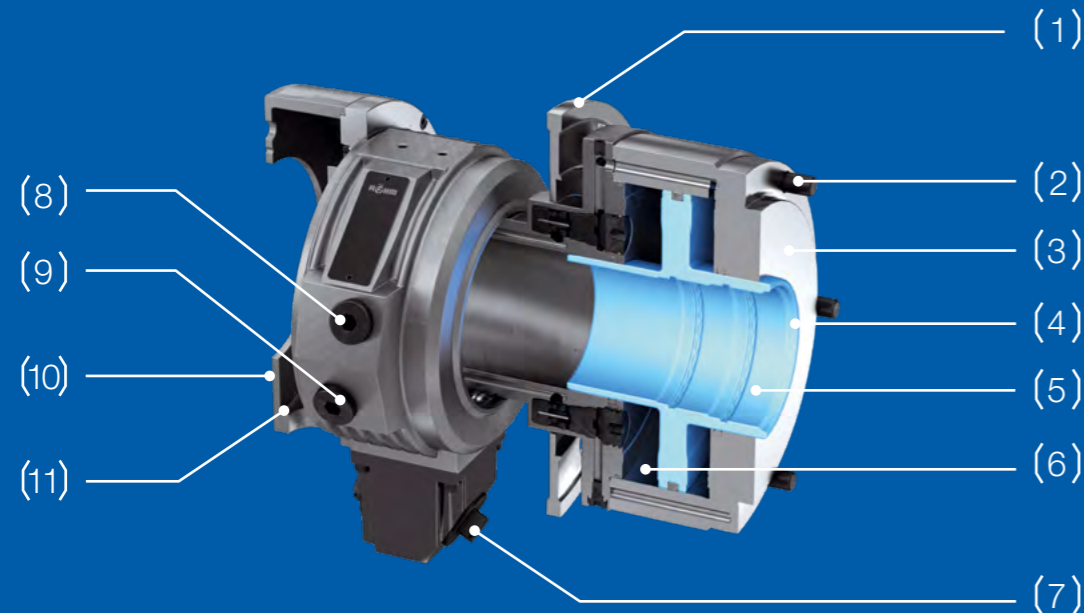

- (1) Switching disc for travel measuring system
- (2) Threaded connection on back side
- (3) Piston housing
- (4) Connection for drawtube
- (5) Piston
- (6) Pressure chamber
- (7) Leakage oil nozzle
- (8) Hydraulic feed (retraction)
- (9) Hydraulic feed (extension)
- (10) Coolant collector
- (11) Coolant drain

## HOW THE FORTO-HT FROM RÖHM WORKS

The aluminium piston housing (3) is connected to the machine spindle by six bolts (2) on the back side. The piston (5) runs on the inside of the piston housing and performs the actuation, i.e. the opening and closing of the clamping device. The piston is hollow on the inside so that longer workpieces can be simply inserted through the cylinder. The hydraulic line (8) is put under pressure to extend the cylinder (and thereby (normally) open the clamping device). Through this, hydraulic oil flows into the compression chamber (6) and moves the piston. The hydraulic line (9) is put under pressure to retract the cylinder (and thereby (normally) close the clamping device). The clamping device and cylinder are connected by a drawtube that is individually

matched to the clamping device. A connection for the drawtube (4) is provided for this on the piston. The switching disc for travel measuring systems (1) is firmly connected to the piston and moves with the piston. Through very tricky placement, the switching disc is placed on the outside and thereby outside the dirty area.

Any coolant running along the workpiece is collected in the coolant collector (10) and fed back to the machine's cooling/lubrication system via the coolant drain (11).



You can find more information on the FORTO-HT on our website:  
[roehm.biz/forto-ht](https://roehm.biz/forto-ht)





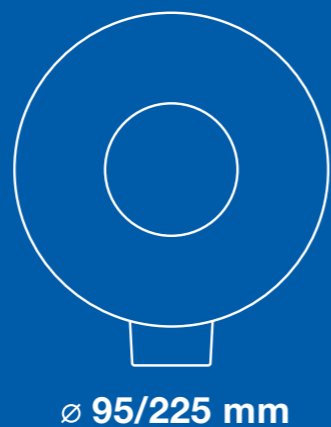
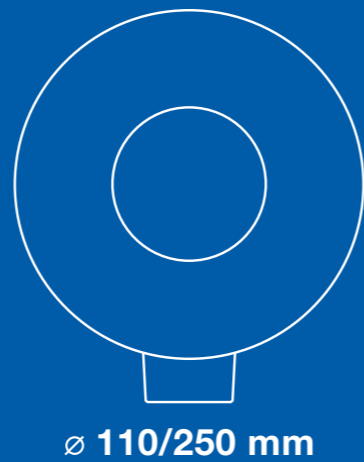
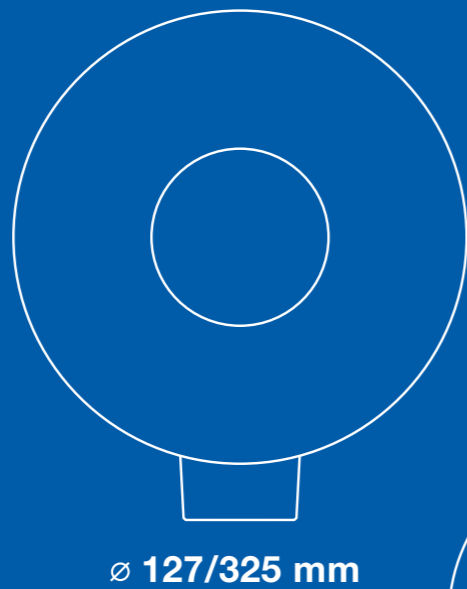
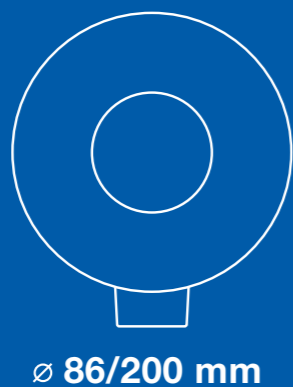
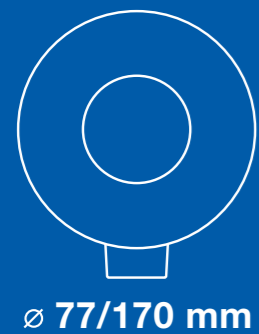
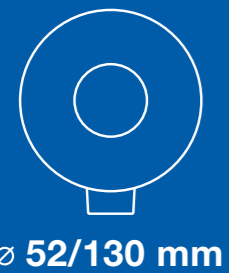
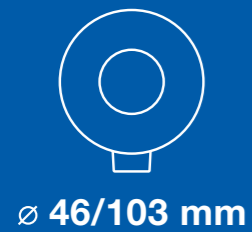

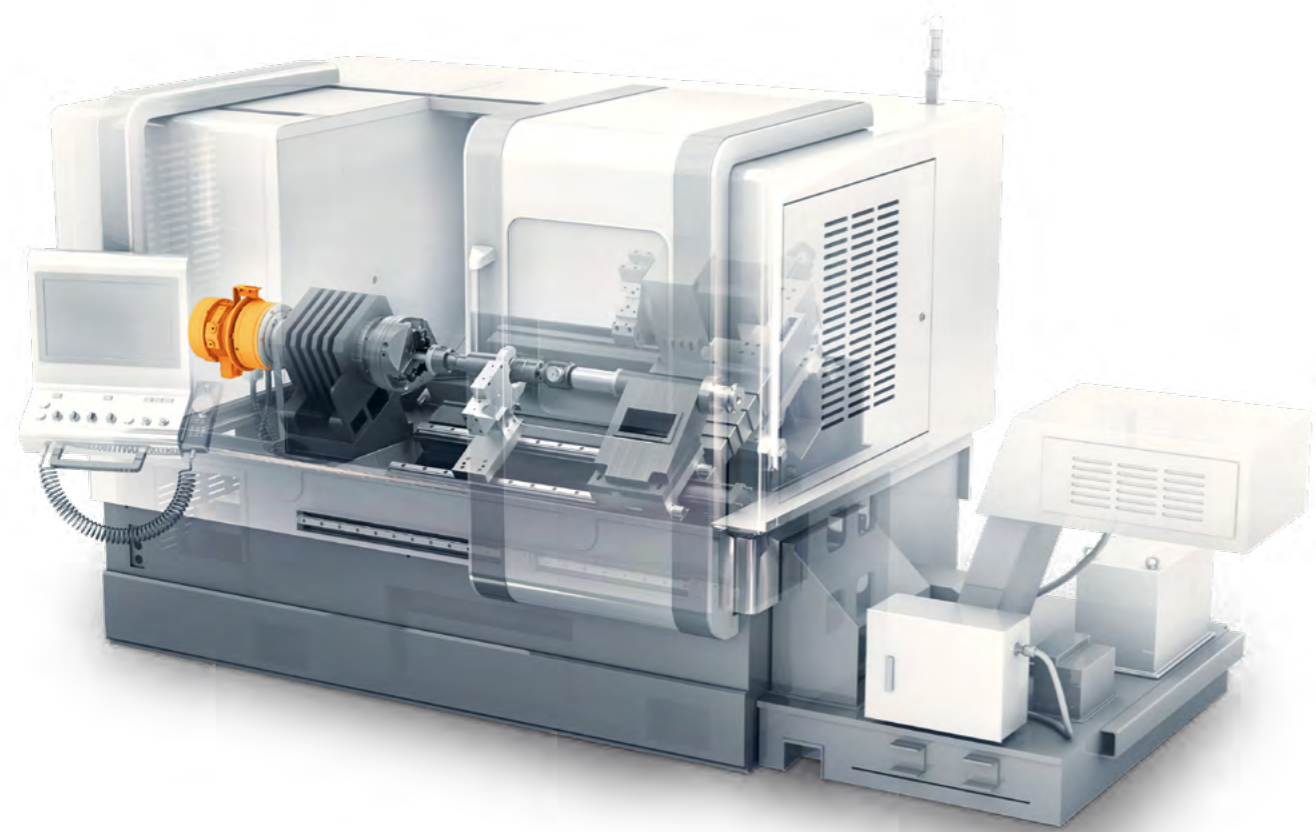

# SO THAT YOU KNOW WHAT TO EXPECT.



Size	37/70	46/103	52/130	67/150	77/170	86/200	95/225	110/250	127/325
Piston stroke [mm]	26	26	26	30	30	35	35	35	40
Max. pressure [bar]	45	45	45	45	45	45	45	45	45
Min. pressure [bar]	8	8	8	8	8	8	8	8	8
Max. actuating force [kN] pull/push	31,6/33,3	46,5/49,4	59/64	68,4/74	76,3/82,7	88,6/95,6	101,7/109,5	111,3/119,3	146,5/151,6
Max. perm. speed [1/min]	8000	7000	6300	5500	5000	4500	4000	4000	3200
Weight [kg]	10	11,5	15,5	20	23,5	29	37	46	58
Through-hole [mm]	37,5	46,5	52,5	67,5	77	86,5	95,5	110,5	127,5
Length [mm]	217	217	232	262	264	289	298	310	335
Max. outer diameter [mm]	170	185	205	222	237	250	269	284	315
Leakage [l/min] at 30 bar /50°	2,5	3	3,5	4	4,5	5	6	8	9
Moment of inertia [kg m²]	0,015	0,024	0,044	0,07	0,092	0,135	0,187	0,26	0,44
Connection thread [mm]	M42x1,5/ M44x1,5	M50x1,5/ M55x2	M55x2/ M60x1,5	M72x1,5/ M75x2	M80x2/ M85x2	M90x2/ M95x2	M100x2/ M105x2	M115x2/ M120x2	M135x2
Spindle connection [mm]	110	130	140	160	160	180	210	210	250
Pitch diameter [mm]	125 - 6xM8	147 - 6xM8	165 - 6xM8	180 - 6xM10	195 - 6xM10	210 - 6xM10	227 - 6xM10	240 - 6xM10	270 - 6xM12
Item No.	443413	443414	443415	443416	443417	443418	443419	443420	443421





## WHAT GOES WITH WHAT

SIZE	37/70	46/103	52/130	67/150	77/170	86/200	95/225	110/250	127/325
 DURO-A	110, 135	165		210		254		315	400
 DURO-A RC			180	215		260		315	400
 DURO-A Plus	110, 140	160	175	200		250		315	400
 CoK-AE	142								
 Captis	32	42	52	65		80		100	120
 Absis	00	01	02			03			
 KZF		40	60			80			

## YOU NEED THE WHOLE SYSTEM ...

The cylinders of the FORTO-HT series are an essential element for clamping on your machine tool. But precise clamping requires additional components. We have the complete system for this.

(1)  ... to be able to clamp at all. There is the matching, force-actuated clamping device from RÖHM for this.

(2)  ... to clamp workpieces correctly. RÖHM offers an extensive range of top jaws for this.

(3)  ... support long rotating pieces with unparalleled precision using a RÖHM self-centering steadyrest.

(4)  ... center long rotating parts with RÖHM's live centers.



... measure clamping force with the RÖHM F-senso chuck. Simply clamp it into the lathe chucks and measure the clamping force.



... equip your material handling robots with one of RÖHM's grippers and swiveling units.

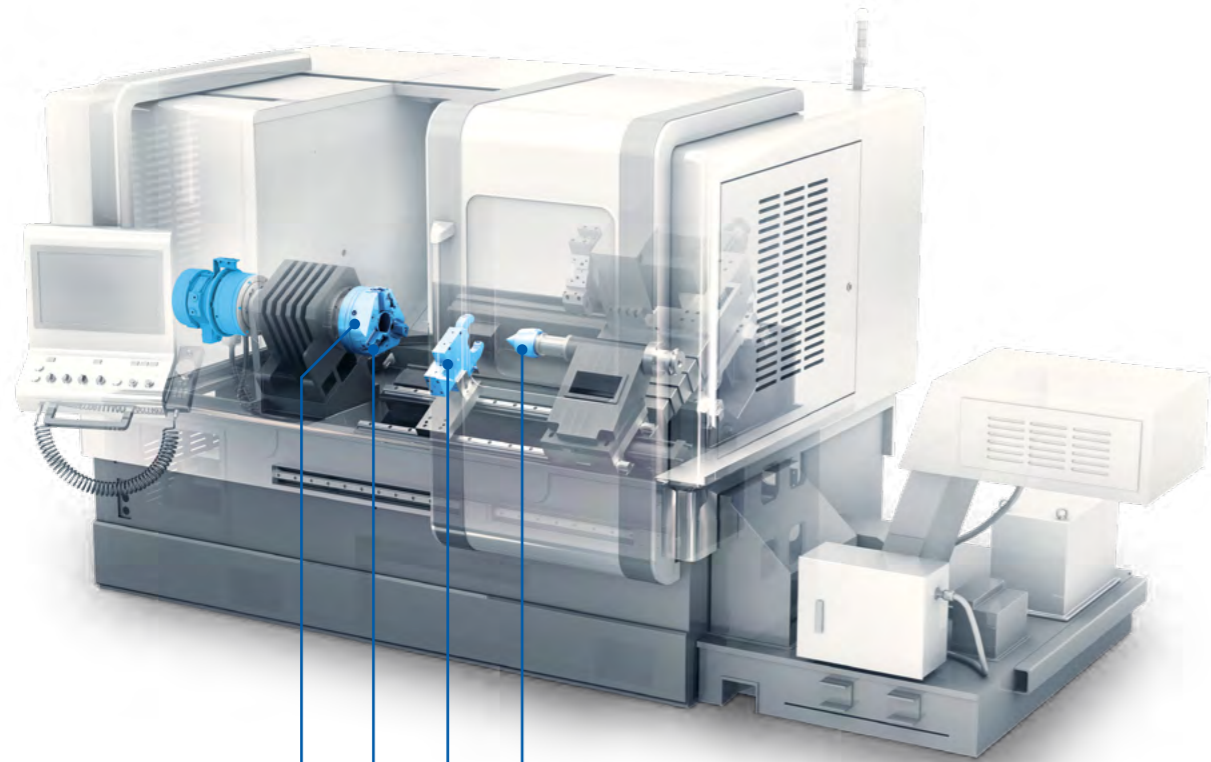

(1) (2) (3) (4)

# PERHAPS YOU NEED SOMETHING A BIT DIFFERENT ...

The FORTO-HT clamps a multitude of force-actuated clamping devices. But perhaps you have requirements that can be covered better with a special solution. Maybe because you have other requirements of the geometries to be machined. Or,

there are other boundary conditions due to the number of units you have to manufacture. In any case, we at Rohm have the right clamping solution. That's a promise.

... if you don't want to machine longer workpieces. Then simply reach for a simple full clamping cylinder without a through-hole: the FORTO-H.



... because you don't have (want) a hydraulic supply on your machine tool. There is the air-operated cylinder (LVS = air-operated full clamping cylinder with safety valve) from RÖHM for this. These cylinders are particularly well suited for applications in which no oil may be used, for example for woodworking.



... because you use manual clamping technology, since you do not have a hydraulic supply on your machine tool. There is the air-operated self-contained chuck (LVE) from RÖHM for this. A pneumatic cylinder and the clamping device are combined in one module here. These cylinder/chuck combinations are very well suited for retrofitting on manual machines. The piston is actuated pneumatically.



# HERE COMES A NEW HOLLOW CLAMPING CYLINDER FOR YOU. THE FORTO-HT. FROM RÖHM.



RÖHM has the right solution for all clamping challenges, whether it's workpiece or tool clamping. We ensure every requirement is met, from customer consultation and design to production and service, to deliver products of the highest quality. Our expert advisors are available to provide further information.



#### USA

Roehm Products of America Inc.  
2500 Northlake Drive  
Suwanee GA 30024

TEL +01 770 963 8440  
FAX +01 770 963 8407  
sales@rohm-products.com  
www.rohm-products.com

#### UK

ROHM (Great Britain) LTD.  
27 Webb Ellis Business Park,  
Woodside Park,  
Rugby, CV21 2NP

TEL +44 17 88 22 84 69  
rohmgb@roehm.biz  
www.roehm.biz/en

#### GERMANY

RÖHM GmbH  
Heinrich-Roehm-Straße 50  
89567 Sontheim/Brenz  
Deutschland

TEL +49 7325 16 400  
sales@roehm.biz  
service@roehm.biz



roehm.biz